



HAPPY GARDENING AND COMPOSTING!



VIDEO TUTORIAL
We help you to build your Ceercle,
scan the QR code to watch it.



COMPACT COMPOSTER

INSTALLATION GUIDE



INSTALL THE COMPACT VERMICOMPOSTER

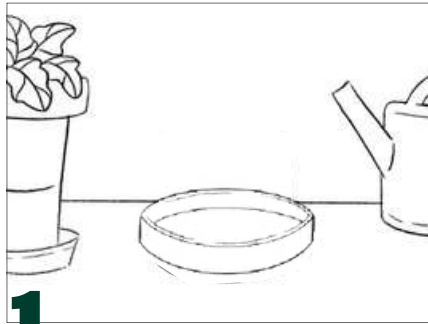

1.

Place the base of your compact vermicomposter in the desired spot.

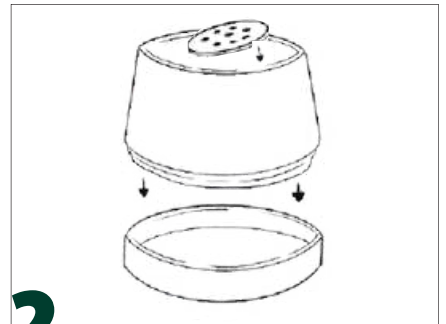

2.

Place your compost floor n°1 on the base and cover the central hole with the openwork piece.

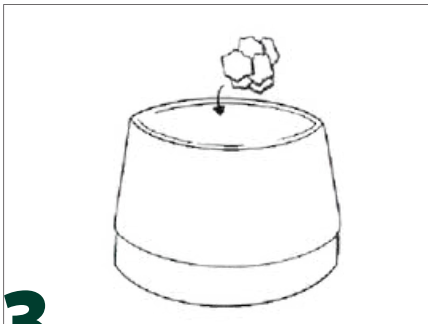

3.

Cut three handfuls of cardboard into small pieces (e.g. from your delivery box). Place them at the bottom of the compost floor.



4.

Pour the inside of the worm bag into the compost floor. Add 4 to 5 cm of biowaste (peelings and cardboard).

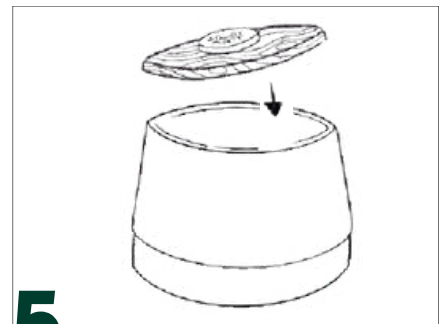

5.

Place the wooden shelf on the top of the compost floor. Close the top of the floor with the terracotta stopper.

ADD AN ADDITIONAL FLOOR

When the first floor of the composter is full after a few weeks, you can add the second floor on top. To do this, we recommend that you :



1.

Take some of the material from the compost floor n° 1 (2 good handfuls containing worms will work).

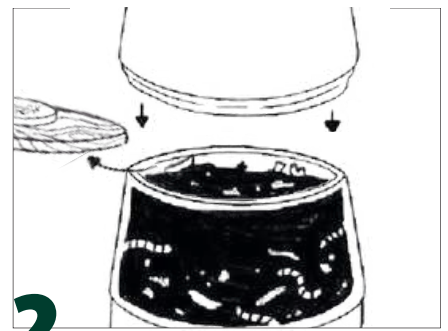

2.

Place compost floor n°2 on top, having first removed the wooden shelf. As with the first floor, you can cover the central hole with the perforated piece.

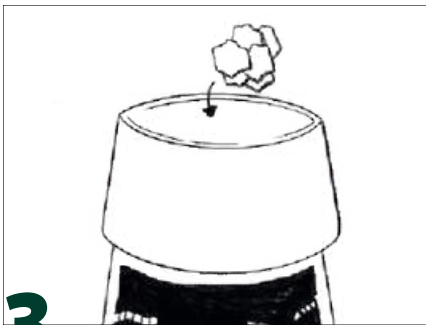

3.

Cut three handfuls of cardboard into small pieces (e.g. from your delivery box). Place them at the bottom of the compost floor.



4.

Place your 2 handfuls containing the worms into the new floor. Add a layer of 4 to 5 cm of biowaste (peelings and cardboard)

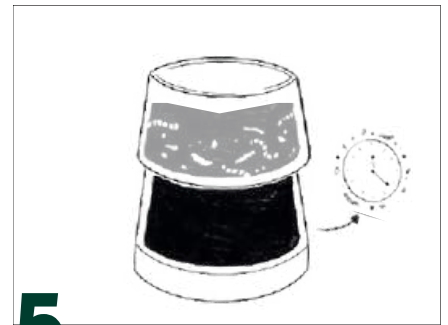

5.

The compost at the bottom will continue to mature, and the compost worms will gradually migrate to the top level, where the fresh food is. Wait a few weeks until the compost has matured before collecting and emptying it.

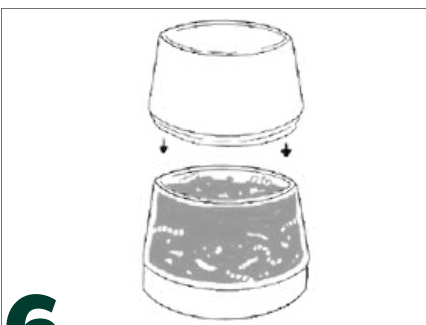

6.

Once the bottom floor has been emptied, it's time to swap compost floors... and so on !

AND ENJOY YOUR COMPOSTER

HARVEST THE COMPOST EVERY 2-3 MONTHS



COLLECT THE COMPOST TEA

